







**MADISON Three-hole basin mixer with pop-up waste - Brushed Durabronz  
(23kt Gold)**

MADISON

20 700 360



- 135mm projection
  - fixed spout
  - circular, air-enriched flow
  - height of mixer 72 mm
  - height up to aerator 40 mm
  - hole diameter valve 32 mm
  - hole diameter spout 35 mm
  - without rosette
  - 2x 1/2" x 1/2" high pressure hose
  - max. flow 7 l/min
  - lead-free
  - This product can help a building meet the requirements of Green Building Rating Systems, e.g. LEED®, BREEAM®, DGNB
- Only suitable for basins with an overflow.

	Brushed Durabronz (23kt Gold)	20 700 360-28
	Chrome	20 700 360-00
	Brushed Platinum	20 700 360-06
	Platinum	20 700 360-08
	Durabronz (23kt Gold)	20 700 360-09
	Brushed Dark Platinum	20 700 360-99

**Recommended miscellaneous**



**High pressure hoses -** 12 506 970 90  
 • 2x 3/8" x 1/2" x 500mm high pressure hose

20 700 360  
mm [inches]

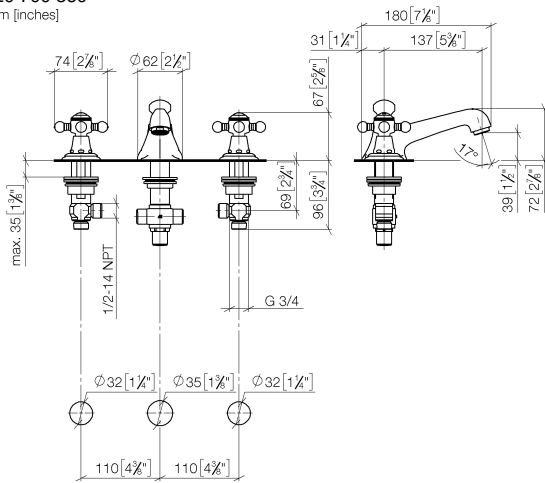

**Flow rate chart**



**Certificates**

GDV\_0400288.

ETA\_17861.

WRAS\_1512009.

LGA\_8027.

20 700 360

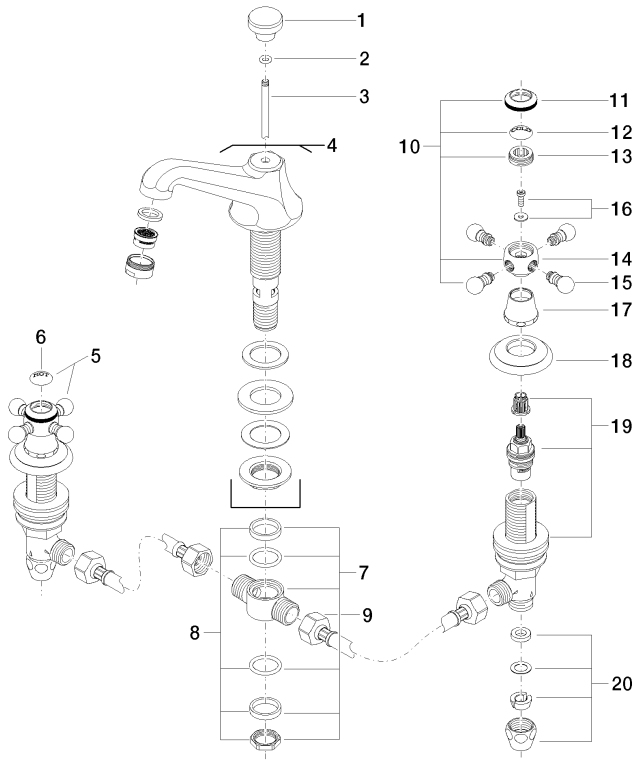

21 ————— Ablaufgarnitur 04.11.01.001.00.FP